

Motic®

MORE THAN MICROSCOPY



LS

BA210RED

SPECIAL PERFORMANCE BIOLOGICAL MICROSCOPE



The new BA210RED

With the BA210RED Motic is setting a new standard in microscope performance through **improvements both in optical and mechanical features.**

Designed to be used in **Educational life science, Medical and a variety of Biological applications**, the new BA210RED is designed for ease of use and longevity due to Motic's complete understanding of the daily demands placed on the standard educational microscope.

Student proof features, working together with a new generation of **Infinity Plan Super Contrast Achromatic objectives** provide a fully corrected intermediate image for crisp and clear visual and digital results.

Whether using the new powerful **3W LED** version, light consuming contrast methods like Polarization, Darkfield, Phase Contrast are easily performed.

Motic BA210 RED is a robust instrument that brings professional, **repeatable image quality** results to all of its intended applications.

BA210RED Standard Specifications

Model	BA210RED
Optical System	Color Corrected Infinity Optical System [CCIS®]
Obsevation Tube	Widefield binocular 30° [F.N.20] Widefield trinocular 30° [F.N.20] - light distribution 50 : 50
EYE-Piece	Wide field WF 10X FOV-20mm (with Diopter on both the eyepieces)
Nosepiece	Reversed quadruple
Stage	140 x 135mm surface; 76 x 40mm movement; coaxial controls Both side Reckless stage
Condenser	N.A. 1.25 Abbe condenser with slider slot; Focusable and Lockable
Focus	Brass gears Z-Axis movement 25mm stroke Fine focus with 2µm minimum increment, Coarse focus with torque adjustment
Illumination	Built-in transmitted 3W LED critical illumination

Objectives

To improve the overall optical performance of the BA210RED, Motic introduces a new generation of Plan Infinity Achromatic Objectives made of **high quality optical glass; CCIS® SC**. These new lenses are now multi-layer coated for **improved contrast** to enhance images even with weak slide stainings.

Together with a new tube lens, the result is a fully corrected, perfected intermediate image without colored fringes. The Trinocular BA210RED gives digital access for even sharper imaging and improved digital output quality for the **ultimate results**.



Magnification	N.A.	W.D. (mm)
Plan SC 4X	0.10	15.5
Plan SC 10X	0.25	17.4
Plan SC 40X, Spring	0.65	0.6
Plan SC 100X, Spring, Oil	1.25	0.14

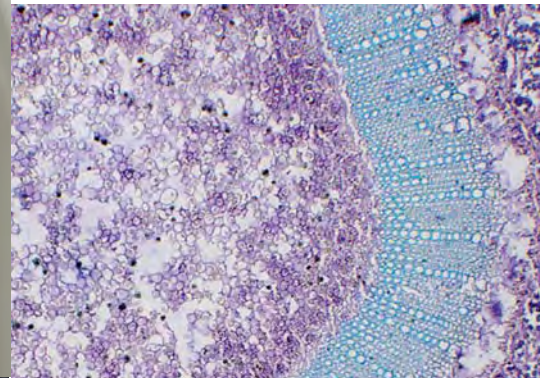

Motic Plan SC

Eyepieces

Standard lockable eyepieces prevent inadmissible removal and confirms Motic's dedication to **student proof quality**.

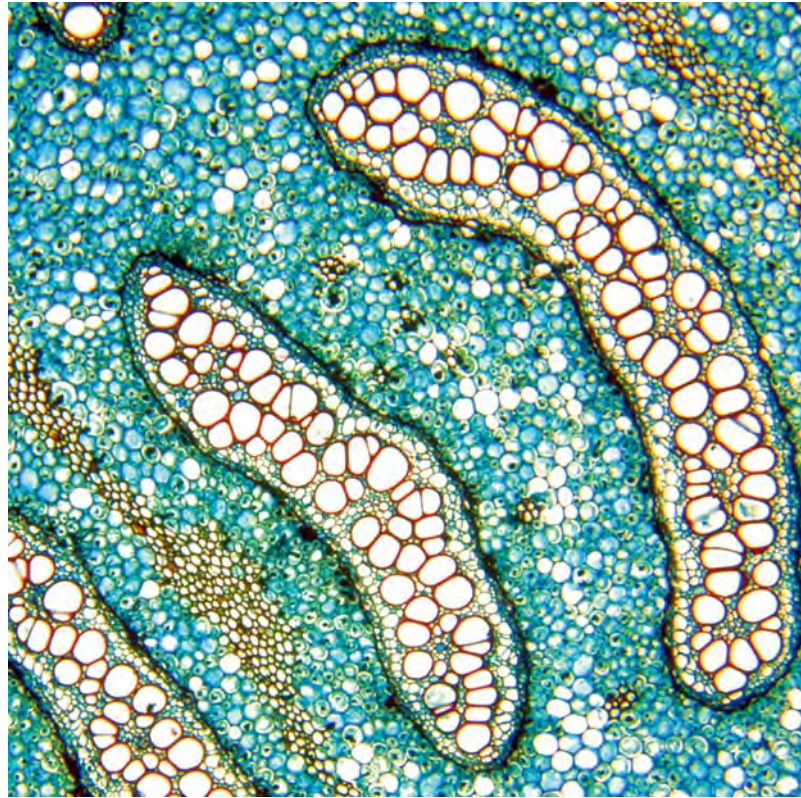
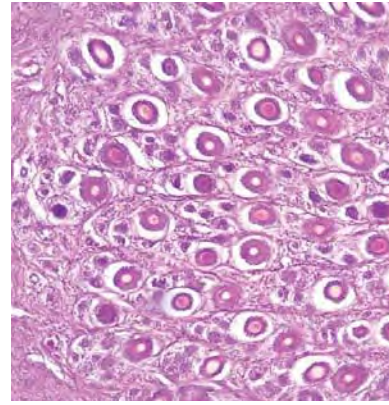

Eyepiece Tubes

Designed with an **ergonomic viewing angle of 30°** and incorporating an **interpupillary distance of 48-75mm**, the BA210RED observation tubes guarantee **fatigue-free viewing for hours**. A large field of view (20mm) enables fast and comfortable screening. The Trinocular tube allows digital documentation by using a wide variety of digital cameras, with a **50:50 light split for the Trinocular exit**.



Condenser Lock

Condenser

To ensure the perfect height adjustment of the condenser, a **condenser lock is integrated**. While using phase/darkfield sliders, the user can **pre-set the condenser position** to prevent potential mis-adjustments.



Stage

The BA210RED comes with a **right hand control stage** and a new slide holder which enables consistent **sample movement across a 76x40mm range**.

The model also offers a hard **coated surface**, resistant against routine usage abrasion.

Rackless Stage

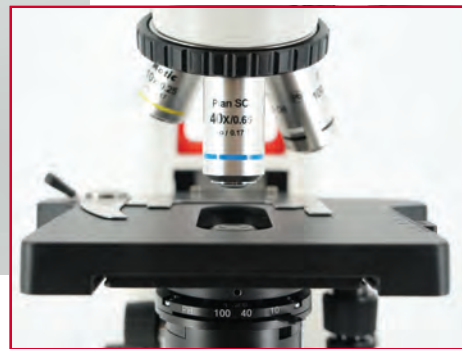

Rackless stage with extra safety feature

LED illumination



Illumination

The BA210RED offers multiple illumination options such as **3W LED or a mirror**.

Anti-Fungus Design

To protect the system from fungus growth in high-humidity environments, an **anti-fungus treatment** is applied to prolong the life of both microscope and objectives.

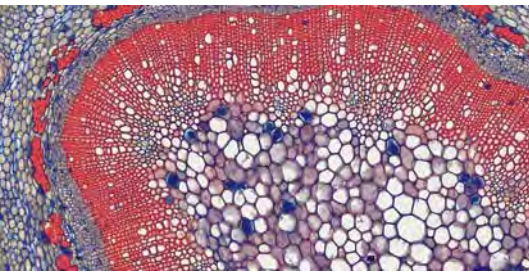

Documentation

The importance of documentation has expanded into every aspect of microscopy, as has the method of documentation. The BA210RED is available with both a traditional method (photomicrography) and a digital method.



Standard Photomicrography

The traditional use of a **single lens reflex camera** (analogue or digital) requires the trinocular version of the BA210RED. The adaptation of the camera consists of a **mechanical adapter** combined with a **photo eyepiece** (2.5X or 4X). The necessary **T2 adapter** referring to the camera model is supplied by the camera manufacturer. This setup delivers high resolution images of small fields.

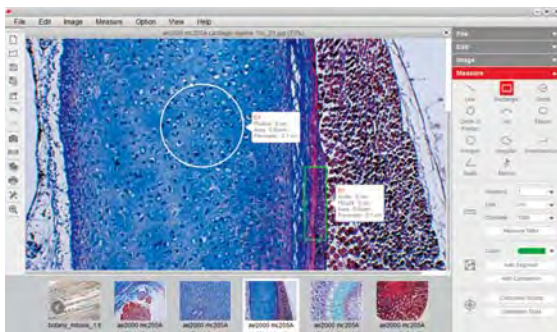

Digital Documentation

Digitalization of microscopic results is Motic's philosophy and the BA210RED provides **two methods**.

The combination of the BA210RED trinocular microscope **with the Moticam Series** of digital cameras delivers crisp live images easy to be saved. **All Motic cameras come equipped with software** to convert the BA210RED into an analysis and documentation station. Should you select a third-party camera, Motic provides a **range of CCD-adapters** covering all demands for field vs. resolution.



BA210RED System Diagram

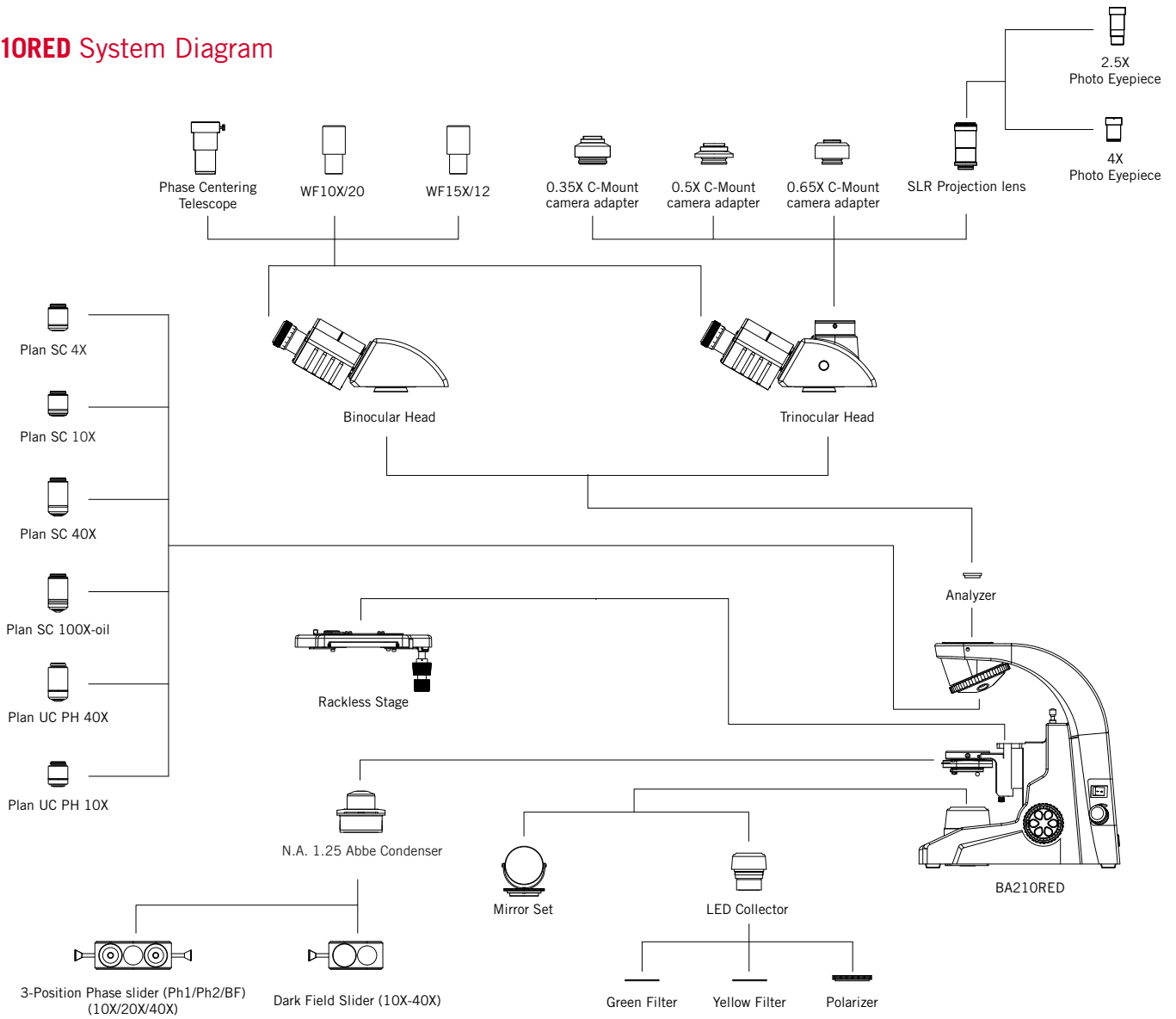

BA210RED Schematic Diagrams

Unit: mm

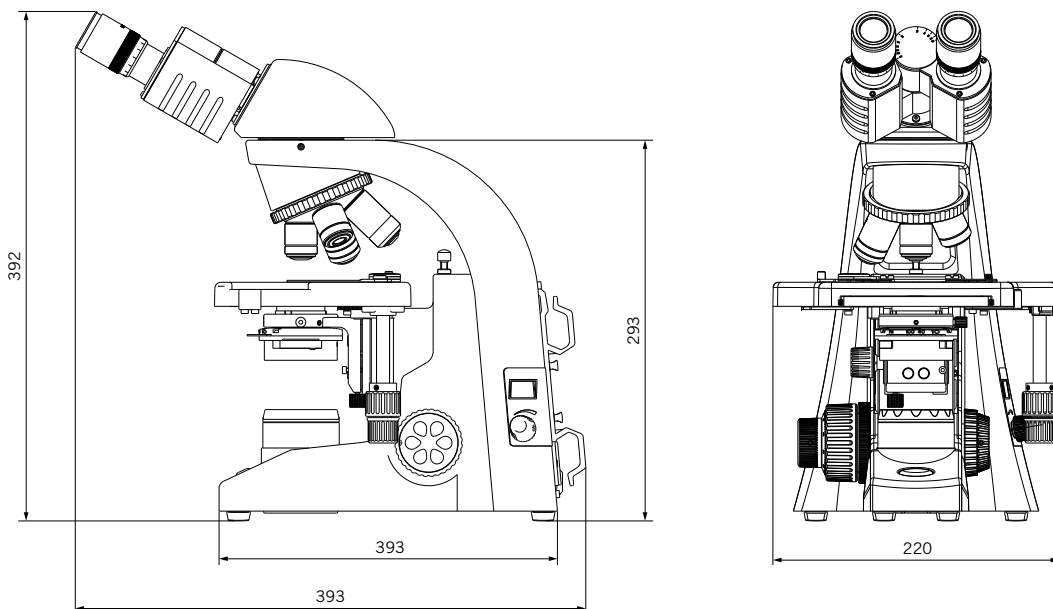



Canada | Germany | Spain | USA



www.motic.com

EN | ES | FR | DE | IT | PT

Motic Instruments (Canada)

130 - 4611 Viking Way, Richmond, BC V6V 2K9 Canada
Tel: 1-877-977 4717 | Fax: 1-604-303 9043

Motic Deutschland (Germany)

Christian-Kremp-Strasse 11, D-35578 Wetzlar, Germany
Tel: 49-6441-210 010 Fax: 49-6441-210 0122

Motic Hong Kong (Hong Kong)

Unit 2002, L20, Tower Two, Enterprise Square Five, 38 Wang Chiu Road,
Kowloon Bay, Kowloon, Hong Kong
Tel: 852-2837 0888 | Fax: 852-2882 2792

Motic Europe (Spain)

C. Les Corts 12, Pol. Ind. Les Corts. 08349 Cabrera de Mar, Barcelona, Spain
Tel: 34 93 756 62 86 | Fax: 34 93 756 62 87

Motic US

6508 Tri-County Parkway, Schertz, TX 78154, United States
Tel: 800-275-3716 | Fax: 210-590-1104

*CCIS® is a trademark of Motic Incorporation Ltd.

Motic Incorporation Limited Copyright © 2002-2020. All Rights Reserved.

Design Change: The manufacturer reserves the right to make changes in instrument design in accordance with scientific and mechanical progress, without notice and without obligation.

Updated: 16.09.2020



Official Distributor: